



Phone #
Fax # EMC&A

Penn Convention Center Panel Replacement

Philadelphia

**Submittal For Leviton Manufacturing Co., Inc.
Dimming and Lighting Control system**



Submittal

Approved By: _____ Date: _____



Bill of Materials # 2244329268

Penn Convention Center Panel Replacement

12-02-2022

This BOM has been created by an authorized user of ASAP Designer's "Advanced BOM" feature. By placing an order using this BOM you hereby acknowledge and agree that it was designed based on the Sales Agent's best interpretation of the information provided to him/her as a request for quotation. Any questions about this quotation, its ability to meet project requirements and/or issues in the field during set up or use, must be directed to the Sales Agent.

ITEM	QTY	PART NO.	DESCRIPTION
1.0			Relay System
1.1	14	R1616-1CB	GreenMAX 16-position Relay Insert Panel (fits 16, 32, 48-relay cabinets), with quantity of 16, Latching, 1-pole, Return-To-Closed basic, 30A 24-277, 347VAC 50/60Hz, Title 24 compliant, ASHRAE 90.1 compliant
1.2	125	RELAY-BFM	GreenMAX Relay, Blank Filler Module, Title 24 compliant, ASHRAE 90.1 compliant
1.3	8	R1600	GreenMAX 16-position Relay Insert Panel (fits 16, 32, 48-relay cabinets), without relays, Title 24 compliant, ASHRAE 90.1 compliant
1.4	3	RELAY-1CB	GreenMAX Relay, Latching, 1-pole, Return-To-Closed basic, 30A 24-277, 347VAC 50/60Hz, Title 24 compliant, ASHRAE 90.1 compliant
1.5	1	R48TC-100	RP4B GreenMAX Relay Cabinet, 48-Relay Size, Surface Mount, Domestic, with Locking Door, Nema 1, Title 24 compliant, ASHRAE 90.1 compliant
1.6	1	R32TC-100	RP4C GreenMAX Relay Cabinet, 32-Relay Size, Surface Mount, Domestic, with Locking Door, Nema 1, Title 24 compliant, ASHRAE 90.1 compliant
1.7	1	R48TC-100	RP4D GreenMAX Relay Cabinet, 48-Relay Size, Surface Mount, Domestic, with Locking Door, Nema 1, Title 24 compliant, ASHRAE 90.1 compliant
1.8	1	R48TC-100	RP4E GreenMAX Relay Cabinet, 48-Relay Size, Surface Mount, Domestic, with Locking Door, Nema 1, Title 24 compliant, ASHRAE 90.1 compliant

 Lighting & Controls 10385 SW AVERY ST TUALATIN, OR 97062 (503) 404-5500 http://www.leviton.com	PROJECT: Penn Convention Center Panel Replacement		
	TITLE: Bill of Materials	QUOTE: 2244329268	LOCATION: Philadelphia
	REVISION: 1	DATE: 12-02-2022	
	PREPARED BY: Paul Farris		COMPANY PHONE:



ITEM	QTY	PART NO.	DESCRIPTION
1.9	1	R48TC-100	RP4F GreenMAX Relay Cabinet, 48-Relay Size, Surface Mount, Domestic, with Locking Door, Nema 1, Title 24 compliant, ASHRAE 90.1 compliant
1.10	1	R32TC-100	RP4G GreenMAX Relay Cabinet, 32-Relay Size, Surface Mount, Domestic, with Locking Door, Nema 1, Title 24 compliant, ASHRAE 90.1 compliant
1.11	1	R48TC-100	RP3A GreenMAX Relay Cabinet, 48-Relay Size, Surface Mount, Domestic, with Locking Door, Nema 1, Title 24 compliant, ASHRAE 90.1 compliant
1.12	1	R48TC-100	RP4A GreenMAX Relay Cabinet, 48-Relay Size, Surface Mount, Domestic, with Locking Door, Nema 1, Title 24 compliant, ASHRAE 90.1 compliant
1.13	8	RPM16-316	GreenMAX relay system Command Module complete with 70W power supply, Main Processor, LumaCAN 3, with 16 Low Voltage inputs. 100-277VAC 50/60Hz, Title 24 compliant, ASHRAE 90.1 compliant
1.14	1	RHDU1-300	LumaCAN 3 Handheld Display Unit for GreenMAX relay systems. Comes complete with rechargeable batteries, Title 24 compliant, ASHRAE 90.1 compliant
2.0			Advanced Bill of Materials
2.1	1	NPRPT-6	LumaCAN 6-Port Repeater
2.2	1	PST24-R41	Power Supply for LumaCAN devices, 24V 4.1A output. 100-240VAC 50/60Hz power input on IEC 60320 receptacle. Full power output on terminals, plus, (3) RJ-45 pairs max 1.5A each. UL, cUL, CE Listed. 1/2 Rack Unit.
2.3	1	EIA00-S01	1RU 19 1/4 1/4 EIA rack, surface mount enclosure, opening in side.
			System Services
	1	Freight	Leviton's standard freight policy and terms are applicable to this ASAP quotation and any resulting order. Freight allowance thresholds are customer-specific. If an order for this quotation does not meet the minimum freight allowance threshold, Leviton will add freight charges to the customer's order.
	1	ECO-C00	Engineering Services: System Check-Out, Commissioning and Training by a Factory Authorized Engineer. Engineering Services require a minimum of three (3) weeks advance notice.

<p>Lighting & Controls 10385 SW AVERY ST TUALATIN, OR 97062 (503) 404-5500 http://www.leviton.com</p>	PROJECT: Penn Convention Center Panel Replacement		
	TITLE: Bill of Materials	QUOTE: 2244329268	LOCATION: Philadelphia
	REVISION: 1	DATE: 12-02-2022	
	PREPARED BY: Paul Farris		COMPANY PHONE:



General Terms and Conditions

1. Any purchases made pursuant to this Quote constitute acceptance of Leviton's Terms of Sale (Leviton.com/en/terms-of-sale), which are the only conditions applicable to purchase under this Quote. Any additional terms contained in Buyer's purchase order, or any other means of correspondence, are expressly rejected.
2. This Quote incorporates the Leviton Quoting Policy by reference (<https://www.leviton.com/en/support/quotepolicy>)
3. This Quote is valid for the term listed above and replaces and voids any prior revisions of a Quote issued by Seller for the same Project Name.
4. Prices are subject to change without notice, and may apply to open orders not yet shipped.
5. Reference this Quote number when ordering.
6. Prior to Leviton's acceptance of a purchase order, lead times and availability are subject to change.
7. All prices in US Dollars unless noted otherwise in the Quote.
8. Prices shown above do not include any taxes that may apply. Any applicable taxes or tariffs (for international shipments) are the responsibility of the Customer.
9. Prices only valid for the quantities shown. Any change in quantity or description will void this Quote and require a revised Quote.

 Lighting & Controls 10385 SW AVERY ST TUALATIN, OR 97062 (503) 404-5500 http://www.leviton.com	PROJECT: Penn Convention Center Panel Replacement		
	TITLE: Bill of Materials	QUOTE: 2244329268	LOCATION: Philadelphia
	REVISION: 1	DATE: 12-02-2022	
	PREPARED BY: Paul Farris		COMPANY PHONE:



READ ME FIRST!























- ✓ THE NOTES IN THIS DRAWING PACKAGE ARE ESSENTIAL TO A SUCCESSFUL INSTALLATION AND OPERATIONAL SYSTEM. PLEASE READ ALL NOTES ON ALL DRAWINGS AND ADHERE TO WIRING CHARTS. ADDITIONAL INFORMATION CAN BE FOUND IN PRODUCT INSTALLATION GUIDES.
- ✓ LEVITON'S CONTROL WIRING INFORMATION MUST BE THE ONLY SOURCE FOR INSTALLATION OF EQUIPMENT. LEVITON CAN NOT ACCEPT RESPONSIBILITY FOR INSTALLATIONS THAT USE 3RD-PARTY DOCUMENTATION.
- ✓ "PROPOSAL" AND "APPROVAL" DRAWINGS ARE NOT INTENDED OR APPROPRIATE FOR INSTALLATION OF EQUIPMENT. DO NOT RUN WIRE OR CONDUIT BASED ON "PROPOSAL" OR "APPROVAL" DRAWINGS.
- ✓ USE ONLY THOSE DIGITAL CONTROL CABLE TYPES AND BRANDS AS SHOWN IN THESE DRAWINGS. LEVITON'S APPLICABLE PRODUCT WARRANTIES WILL BE VOID UNLESS LEVITON APPROVED CABLES ARE USED.
- ✓ ADHERE TO THE WIRING FORMAT OR METHOD AS SHOWN ON THE SYSTEM BLOCK DIAGRAM FOR THIS PROJECT.
- ✓ DIGITAL CONTROL CABLE RUNS HAVE MAXIMUM LENGTH LIMITATIONS. RUNS THAT EXCEED THIS LENGTH WILL NOT FUNCTION. CONSULT PRODUCT INSTALLATION DOCUMENTS FOR DETAILS.
- ✓ LOW VOLTAGE POWER SUPPLY CABLE RUNS MUST BE SIZED CORRECTLY FOR THE DISTANCE OF TRAVEL, AVAILABLE CURRENT AND TOTAL LOAD OF CONTROL DEVICES. CONSULT PRODUCT INSTALLATION DOCUMENTS FOR DETAILS.

FAILURE TO ADHERE TO THE ABOVE GUIDELINES MAY VOID THE WARRANTY.

IF YOU HAVE INSTALLATION QUESTIONS, STOP AND CALL: 800-959-6004

SYMBOLS

-  POWER LOAD BY INSTALLER
-  POWER FEED BY INSTALLER
-  CONNECTOR BODY-FEMALE [CABLE MT'G]
-  PLUG-MALE [CABLE MT'G]
-  RECEPTACLE-FEMALE [PANEL MT'G]
-  INLET-MALE [PANEL MT'G]
-  CROSSING WIRES, NO CONNECTION
-  CONNECTED WIRES
-  TWISTED PAIR WIRES
-  BUNDLE WIRES SPLIT FROM BUNDLE. BOTH BUNDLE AND SPLIT LABELED.
-  SPLIT
-  # & # DEVICE ADDRESS
-  # DEVICE SLAVE ADDRESS
-  L# STATION LOCKOUT CIRCUIT
-  # CABLES FURNISHED BY LEVITON
-  # WIRE RUNS NOT BY LEVITON
-  A WIRE RUN CONTINUATION REFERENCE
-  1 LUMACAN POWER SEGMENT LOCATION. REMOVE JUMPER AT INDICATED DEVICE.
-  INDICATES DEVICE HAS WIRELESS CONNECTIVITY.
-  # REFERENCE TO REVISION NOTE LISTED IN BORDER.
-  # NOTES BY SYMBOL. MAY BE USED FOR OPERATIONAL NOTE OR ASSEMBLY NOTE.

INDEX OF DRAWINGS

DESCRIPTION	DRAWING NO.	CURRENT RELEASE	NO. OF SHEETS
SYSTEM BLOCK DIAGRAM			
SYSTEM BLOCK DIAGRAM NOTES	110.0	A	2
SYSTEM BLOCK DIAGRAM	111.0	A	1
SCHEDULES			
SCHEDULES KEY CHARTS	120.0	A	1
SCHEDULES	121.1	A	8

CHANGE NOTES



REV	DATE	DESCRIPTION
0	4/4/08	CHANGED PER COMMENTS * RETURNED DRAWINGS * CUSTOMER REQUEST.

LEVITON
CONTROLS

20497 SW Teton Ave.
Tualatin, OR 97062-8812
USA
+1 503.404.5500

PROVIDED BY

PAUL FARRIS

PROJECT PHASE
PRODUCTION

DATE
12-02-2022

SCALE
NONE

DIMENSION

RELEASE

TITLE

INDEX OF DRAWINGS,
SYMBOLS, AND
SYMBOLS USE
KEY

PROJECT

PENN
CONVENTION
CENTER PANEL
REPLACEMENT

PA

ASAP # -DWG
2244329268-100.0

SHEET
1 OF 2

SYMBOL USE KEY

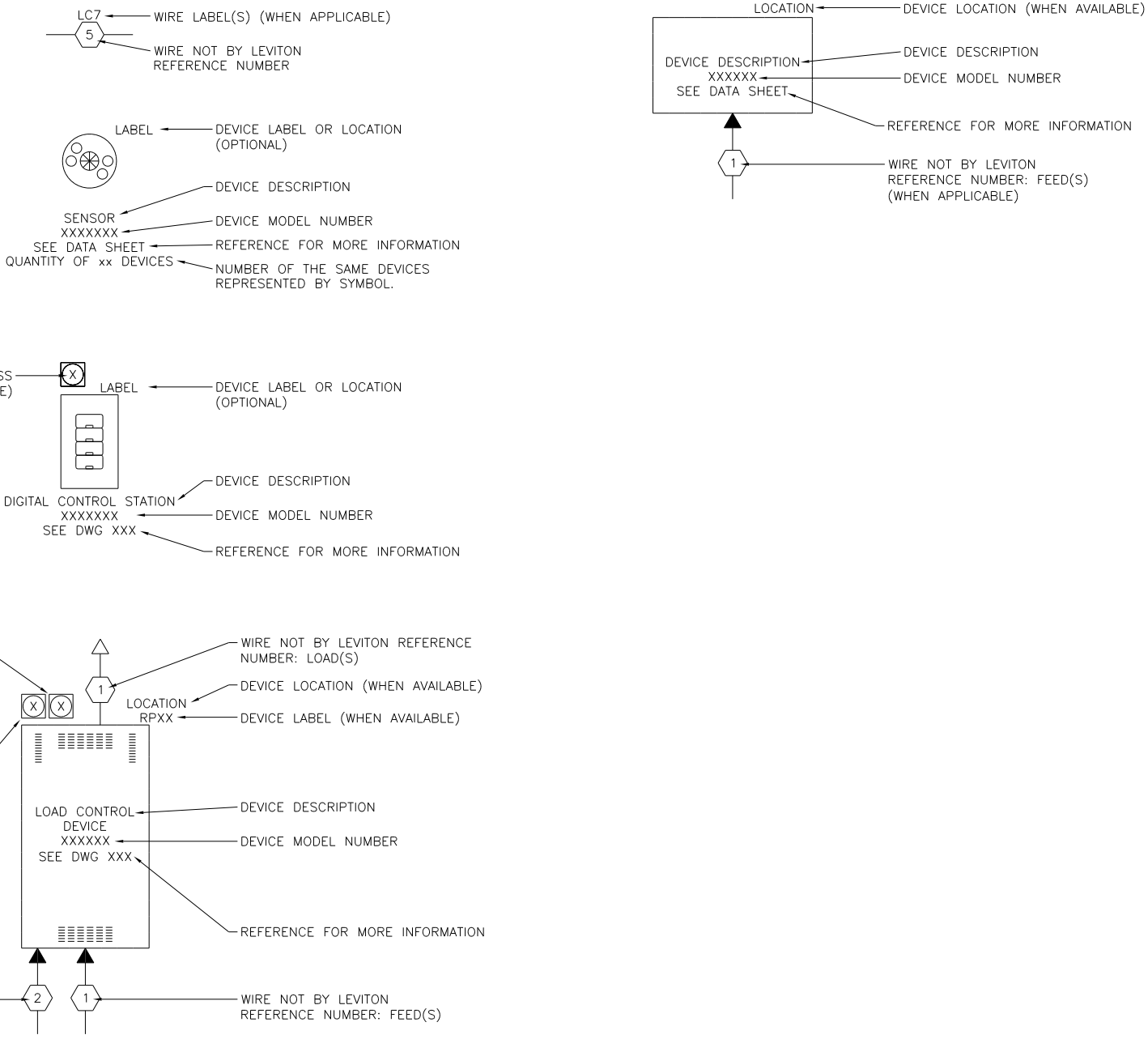

LEVITON
CONTROLS

20497 SW Teton Ave.
 Tualatin, OR 97062-8812
 USA
 +1 503.404.5500

PROVIDED BY

PAUL FARRIS

PROJECT PHASE
 PRODUCTION

DATE
 12-02-2022

SCALE
 NONE

DIMENSION

RELEASE

TITLE

INDEX OF DRAWINGS,
 SYMBOLS, AND
 SYMBOLS USE
 KEY

PROJECT

PENN
 CONVENTION
 CENTER PANEL
 REPLACEMENT

PA

ASAP # -DWG
 2244329268-100.0

SHEET
 2 OF 2

GENERAL NOTES: (UNLESS OTHERWISE SPECIFIED)

- 1 REFER TO BILL OF MATERIALS FOR INCLUDED STAND-ALONE BOXED GOODS, PORTABLE EQUIPMENT, SPARES, ACCESSORIES AND OTHER EQUIPMENT NOT SHOWN ON THESE DRAWINGS. REFER TO DEVICE DATA SHEETS OR INSTALLATION LITERATURE FOR ADDITIONAL INFORMATION. SYSTEM DRAWINGS BASED ON LEVITON QUOTE. AN ORDER WILL ONLY BE ACCEPTED PER LEVITON'S BILL OF MATERIALS. INSTALLING CONTRACTOR TO ENSURE THAT LEVITON LIGHTING CONTROL EQUIPMENT IS BAGGED, COVERED AND KEPT CLEAN AND FREE OF DEBRIS, OVER-SPRAY, DUST, AND OTHER CONTAMINANTS PRIOR TO AND AFTER INSTALLATION.
- 2 IF ENGINEERING CHECKOUT WAS PURCHASED, NO PART OF THIS SYSTEM SHALL BE ENERGIZED BEFORE BEING CHECKED AND INSTALLATION APPROVED BY A LEVITON ENGINEER. LEVITON MUST BE NOTIFIED IN WRITING AT LEAST 3 WEEKS PRIOR TO THE ENERGIZING OF THE SYSTEM. FAILURE TO OBSERVE THESE RESTRICTIONS SHALL AUTOMATICALLY RELIEVE LEVITON OF ANY RESPONSIBILITY CONCERNING THE PROPER OPERATION OF THIS SYSTEM OR ANY PART THEREOF, AND THE REPLACEMENT OF PARTS WHICH MAY HAVE BEEN DAMAGED BY PREMATURE ENERGIZING OF THE SYSTEM.
- 3 CIRCUMSTANCES THAT ARISE FROM FAILURE TO ADHERE TO LEVITON INSTALLATION GUIDELINES ARE SUBJECT TO ADDITIONAL CHARGES. ADDITIONALLY, IF SYSTEM-CRITICAL INFORMATION IS NOT FURNISHED TO LEVITON PRIOR TO QUOTATION OR DURING SUBMITTAL REVIEW, RESULTANT SYSTEM FUNCTIONALITY MAY BE ADVERSELY IMPACTED. AS SUCH, ADDITIONAL EQUIPMENT AND/OR LEVITON FACTORY SERVICE VISIT(S) MAY BE REQUIRED AT ADDITIONAL EXPENSE.
- 4 ALL CLASS 2 LOW VOLTAGE AND NETWORK WIRING SHALL BE RUN SEPARATE FROM LINE VOLTAGE WIRING PER NEC, LOCAL CODES, AND BEST PRACTICES UNLESS OTHERWISE NOTED.
- 5 PROVIDE AN EQUIPMENT GROUND, AS REQUIRED BY THE NATIONAL ELECTRICAL CODE, BETWEEN BUILDING SERVICE ENTRANCE AND THE DIMMER AND OR RELAY EQUIPMENT.
- 6 THIS DRAWING DOES NOT INDICATE THE NUMBER OR SIZE OF CONDUITS REQUIRED, BUT THE SEPARATION OF GROUPS OF WIRES. INTERCONNECTING WIRE AND CONDUIT ARE NOT BY LEVITON.
- 7 INDUSTRY STANDARD GROUNDED BACK BOXES NOT BY LEVITON.
- 8 INTERFACE OF LEVITON EQUIPMENT WITH EQUIPMENT BY OTHERS IS THE SOLE RESPONSIBILITY OF THE ELECTRICAL CONTRACTOR.
 - LEVITON ASSUMES NO RESPONSIBILITY FOR THE FUNCTIONALITY OF EQUIPMENT BY OTHERS AS IT RELATES TO THIS SYSTEM, OR LEVITON SYSTEMS UNDER SEPARATE CONTRACT.
 - LAMP AND TRANSFORMER OR BALLAST COMBINATION COMPATIBILITY MUST BE VERIFIED BY THEIR RESPECTIVE MANUFACTURERS.
- 9 SET DEVICE ADDRESS TO THE NUMBER SHOWN IN THE SYMBOL, OR TO A DISCRETE ADDRESS IF NOT SHOWN. REFERENCE PRODUCT LITERATURE AND PROTOCOL SPECIFIC NOTE(S) FOR ADDITIONAL INFORMATION.
 - SET LOAD CONTROL ADDRESSES FIRST (LOWEST ADDRESSES).
 - SET DEVICE ACTING AS THE MASTER (TIME CONTROL) AS THE FIRST ADDRESS.
- 10 LED LIGHTING SOURCES MUST BE TESTED WITH THE CONTROL SYSTEM FOR COMPATIBILITY.
 - EVERY DIFFERENT TYPE OF SOURCE TO BE CONTROLLED MUST BE TESTED FOR COMPATIBILITY WITH ITS RESPECTIVE, FIELD CIRCUIT SPECIFIC, CONTROL DEVICE(S).
 - QUANTITY OF SAME TYPE SOURCES SUBMITTED FOR TEST MUST BE NO-LESS-THAN THE MINIMUM NUMBER REQUIRED FOR PROPER LOAD CONTROL DEVICE LOADING. LEVITON TO SPECIFY THE QUANTITY REQUIRED.
 - THE MANUFACTURER'S MODEL NUMBERS THAT HAVE BEEN SPECIFICALLY NOTED ON LEVITON LITERATURE MAY BE EXEMPT FROM THE TEST APPROVAL PROCESS WITH LEVITON'S WRITTEN APPROVAL.
 - PRODUCTS SPECIFICALLY MARKED AS NEMA SSL7A COMPLIANT MAY BE EXEMPT FROM THE TEST APPROVAL PROCESS WITH LEVITON'S WRITTEN APPROVAL.
 - DLC LISTED OR DLC APPROVED PRODUCTS MAY BE EXEMPT FROM THE TEST APPROVAL PROCESS WITH LEVITON'S WRITTEN APPROVAL.
 - SOURCE SUBSTITUTION(S) CANNOT BE MADE WITHOUT COMPATIBILITY TESTING.
- 11 0-10V DIMMING BALLASTS AND CONTROLLERS:
 - CIRCUITS TO BE DIMMED BY THIS SYSTEM MUST BE COMPLIANT WITH IEC60928 ANNEX E 0-10V DIMMING. CIRCUITS REQUIRING DIMMING THAT ARE NOT COMPATIBLE MAY REQUIRE ADDITIONAL EQUIPMENT.
 - 2 #18AWG MIN. WIRES PER ZONE ARE REQUIRED (VIOLET & GRAY) AND ADDITIONAL EQUIPMENT MAY BE REQUIRED.
 - 0-10V RUNS CLASS 1 OR CLASS 2 PER NEC, LOCAL CODES, AND BEST PRACTICES.
- 12 DIMMING BALLASTS AND CONTROLLERS (GENERAL):
 - LEVITON WILL NEED EQUIPMENT TYPE, MANUFACTURER, AND MODEL DATA IN ORDER TO ENSURE COMPATIBILITY WITH THE LIGHTING SYSTEM.
 - DISSIMILAR BALLASTS/CONTROLLERS ON THE SAME CONTROL CIRCUIT IS NOT RECOMMENDED.
 - DIMMING RANGE IS DICTATED BY THE BALLAST/CONTROLLER USED.
 - FLUORESCENT DIMMING RANGE IS FROM 100% TO THE LOWEST LEVEL ALLOWED BY THE BALLAST USED.
 - BALLASTS AND CONTROLLERS NOT BY LEVITON.
- 13 ANALOG CONTROL CABLE WIRE RUNS:
 - ONE (1) #18 AWG STRANDED CU CONTROL WIRE PER CONDUCTOR, LABELED PER TERMINATION LABEL, TYPICAL.
 - BUNDLING, OR PROVIDING MULTI-CONDUCTOR CABLES MEETING THESE REQUIREMENTS, IS AT THE DISCRETION OF THE ELECTRICAL CONTRACTOR AND MUST COMPLY WITH APPLICABLE CODES AND BEST PRACTICES.
 - FROM END TO END NOT TO EXCEED 1000 FEET.
 - 10% SPARES RECOMMENDED.
 - MULTIPLE CONTROL DEVICES TERMINATED TO THE SAME ANALOG INPUT ARE TO BE RUN IN PARALLEL. ADDITIONAL POWER MAY BE REQUIRED FOR POWERED DEVICES.
 - DO NOT MIX DISSIMILAR CONTROL DEVICES TO THE SAME ANALOG INPUT.
- 14 EMERGENCY TRANSFER SWITCH, EMERGENCY LIGHTING CONTACTOR, AND OTHER EMERGENCY EQUIPMENT IS NOT BY LEVITON UNLESS OTHERWISE SHOWN.
- 15 RELAY PANEL(S) WITH EMERGENCY CIRCUITS REQUIRE:
 - CONTROL MODULE POWER SOURCE MUST BE ON EMERGENCY/NORMAL POWER UPSTREAM OF RELAY PANEL(S), IF CONTROL IS REQUIRED UNDER EMERGENCY CONDITIONS.
 - EMERGENCY RELAYS MUST BE ADJACENT TO CONTROL MODULE IN ZMAX. VOLTAGE BARRIER IN RELAY RACK WILL SEPARATE EMERGENCY CIRCUITS FROM NORMAL CIRCUITS IN THE SAME RELAY PANEL.
 - A DRY CONTACT CLOSURE MUST BE PROVIDED TO ACTIVATE THE EMERGENCY STATE IN THE RELAY PANEL(S).
 - COMPLIANCE WITH LOCAL CODES IS THE RESPONSIBILITY OF THE INSTALLING CONTRACTOR.
- 16 GREENMAX ANALOG INPUT NOTES:
 - LOW VOLTAGE (ANALOG) STATION BUTTONS THAT TERMINATE AT THE SAME ANALOG INPUT MAY BE DAISY CHAINED TOGETHER.
 - OCCUPANCY SENSORS THAT TERMINATE AT THE SAME ANALOG INPUT MAY BE DAISY CHAINED TOGETHER AND REQUIRE ADDITIONAL POWER EXTERNAL TO THE GREENMAX PANEL. SEE ANALOG INPUT SCHEDULES(S) FOR INPUT(S) UTILIZING AUXILIARY POWER.
 - OCCUPANCY SENSORS, PHOTOCELLS AND SWITCHES MAY NOT BE COMBINED ON A SINGLE INPUT.
 - EACH PHOTOCELL MUST USE A DISCRETE ANALOG INPUT.
 - REFER TO LUMA-CAN NOTE WHEN USING GREENMAX DIGITAL STATIONS.
- 17 GREENMAX BAS/BMS CONNECTIVITY: BACNET/IP PROTOCOL IS NATIVE TO GREENMAX RELAY PANELS. CONNECT BACNET/IP VIA THE ETHERNET NETWORK PORT FOR INTEGRATION.



20497 SW Teton Ave.
Tualatin, OR 97062-8812
USA
+1 503.404.5500

PROVIDED BY

PAUL FARRIS

PROJECT PHASE
PRODUCTION
DATE
12-02-2022
SCALE
NONE
DIMENSION
RELEASE

TITLE
SYSTEM BLOCK
DIAGRAM NOTES

PROJECT
PENN
CONVENTION
CENTER PANEL
REPLACEMENT
PA

ASAP # -DWG
2244329268-110.0

SHEET
1 OF 2

PLOT STAMP: Dec. 02, 2022 (10:34 AM) PLOTTED BY: LOCAL SERVICE

WIRE RUNS NOT BY LEVITON 

18 GREENMAX RELAY PANELS:

- ALLOW OPERATION OF ANY RELAY FROM ANY INPUT AS STAND-ALONE & WHEN NETWORKED TOGETHER. NETWORK DEVICE LIMITATION OF 250 ADDRESSED DEVICES.
- GREENMAX RELAY PANELS COME STANDARD WITH NO ANALOG INPUTS, BUT ARE EXPANDABLE IN GROUPS OF 8 INPUTS TO A MAXIMUM OF 16.
- GREENMAX NETWORK REMOTE INPUT CABINETS ARE AVAILABLE IN 8 AND 16 INPUT VERSIONS.

- 1 REFER TO DEVICE CIRCUIT SCHEDULE(S) OR DEVICE TYPE FOR ASSOCIATED FEED AND LOAD CIRCUIT QUANTITY AND TYPE(S).
- 2 GREENMAX CONTROL POWER: 1 AMP, 120VAC OR 277VAC 2 WIRE PLUS GROUND, 60HZ. DEDICATED SOURCE. POWER SHOULD BE PROVIDED TO THE CONTROL PROCESSOR IN BOTH NORMAL AND EMERGENCY CONDITIONS, IF CONTROL IS REQUIRED UNDER EMERGENCY CONDITIONS.
- 3 (1) LUMACAN CABLE: BELDEN 2412 TERMINATED PER EIA/TIA 568B LABELED PER DRAWING. RJ45 PASS-THROUGH CONNECTORS PROHIBITED.

19 LUMACAN WIRING NOTES:

- TOTAL CABLE RUN (INCLUDING PLUG-IN CABLES) OR SEGMENT LENGTH BETWEEN REPEATERS, NOT TO EXCEED 1600' [485M]. TOTAL END TO END RUN LENGTH NOT TO EXCEED 10,000' [3048M].
- RJ45 PASS-THROUGH CONNECTORS PROHIBITED.
- TOTAL CABLE RUN LENGTH FROM POWER SUPPLY TO LAST POWERED DEVICE NOT TO EXCEED POWER SUPPLY LIMITS AND CABLE CURRENT CARRYING CAPACITY.
- SEQUENTIAL (DAISY CHAIN TOPOLOGY) CONNECTION ONLY; NO BRANCHING ALLOWED UNLESS A LUMACAN REPEATER IS USED.
- DEVICES ARE TO BE CONNECTED AS SHOWN. INSTALLING CONTRACTOR TO PROVIDE COORDINATION TO REQUIRED FACILITY INFRASTRUCTURE, OUTLINING DIFFERENT CONNECTION ORDER THAT MAY BE REQUIRED BY FACILITY. UPON EXAMINATION, ADDITIONAL SYSTEM INSTALLATION COORDINATION MAY BE REQUIRED TO ENSURE A WORKING SYSTEM.
- NO MORE THAN 110 DEVICES CONNECTED TO THE NETWORK BETWEEN REPEATERS, NO MORE THAN 250 DEVICES PER NETWORK.
- SEPARATE LUMACAN POWER SUPPLIES ON THE SAME CABLE RUN AS REQUIRED.



20497 SW Teton Ave.
Tualatin, OR 97062-8812
USA
+1 503.404.5500

PROVIDED BY

PAUL FARRIS

PROJECT PHASE
PRODUCTION

DATE
12-02-2022

SCALE
NONE

DIMENSION

RELEASE

TITLE
SYSTEM BLOCK
DIAGRAM NOTES

PROJECT
PENN
CONVENTION
CENTER PANEL
REPLACEMENT
PA

ASAP # -DWG
2244329268-110.0

SHEET
2 OF 2

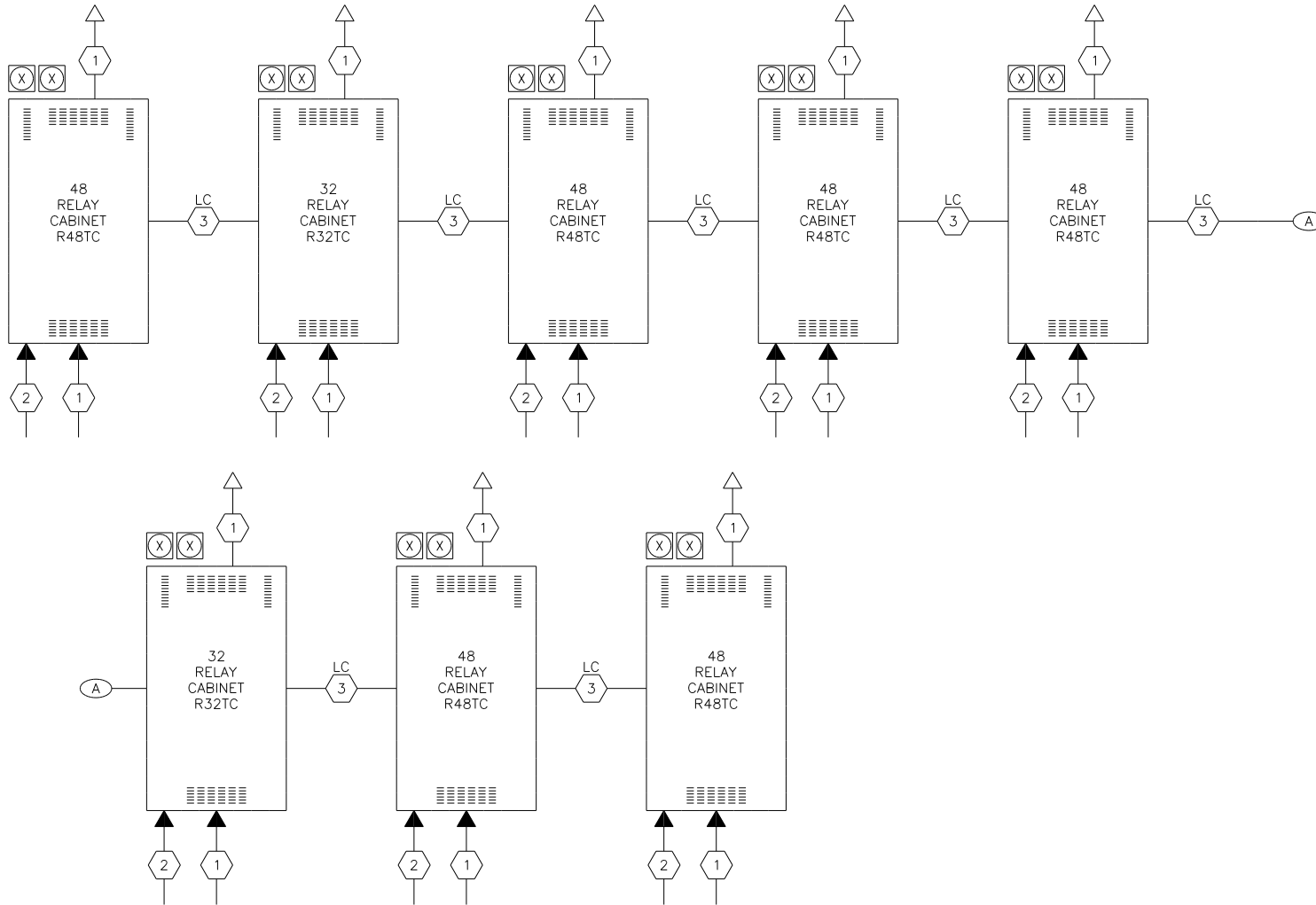

**LEVITON
CONTROLS**

20497 SW Teton Ave.
Tualatin, OR 97062-8812
USA
+1 503.404.5500

PROVIDED BY

PAUL FARRIS

PROJECT PHASE
PRODUCTION

DATE
12-02-2022

SCALE
NONE

DIMENSION

RELEASE

TITLE

SYSTEM BLOCK
DIAGRAM

PROJECT

PENN
CONVENTION
CENTER PANEL
REPLACEMENT

PA

ASAP # -DWG
2244329268-111.0

SHEET
1 OF 1

SCHEDULE KEY CHARTS

GENERAL NOTES	
(EM)	EMERGENCY CIRCUIT

GREENMAX INPUT TYPES	
OS	OCCUPANCY SENSOR
PC	PHOTOCELL
S1	LV SWITCH - SINGLE BUTTON ON/OFF
S2	LV SWITCH BUTTON
CC	CONTACT CLOSURE

EZ-MAX INPUTS	
SWITCH TYPE	
SWT	SWITCH
OCC	OCCUPANCY SENSOR
PCC	PHOTOCELL, 0-10V
PCS	PHOTOCELL, SWITCHED

ACTION TYPE: SWITCH (SWT)	
MOM	MOMENTARY
MMT	MOMENTARY TIMED
MAINT	MAINTAINED
PRON	PRESS ON
PROFF	PRESS OFF
MOMNF	MOMENTARY ON/OFF (GE)

ACTION TYPE: OCCUPANCY SENSOR (OCC)	
MANAUT	MANUAL ON / AUTO OFF
AUTAUT	AUTO ON / AUTO OFF
SPEAUT	SPECIAL ON / AUTO OFF

ACTION TYPE: PHOTOCELL, 0-10V (PCC)	
RELFOR	RELINQUISH ON / FORCE OFF
FORFOR	FORCE ON / FORCE OFF
FORREL	FORCE ON / RELINQUISH OFF

ACTION TYPE: PHOTOCELL, SWITCHED (PCS)	
ALT	ALTERNATE
MAIN	MAINTAIN

LOAD SCHEDULE LOAD TYPES AND DIMMER FUNCTION				
ABBREV.	DESCRIPTION	DEVICE SETTINGS		
		i-SERIES e	a-2000	Dxx0x
ST	STANDARD DIMMING	INC	DM, HD	ST
M7	ADVANCE MARK VII BALLAST	INC*	M7**	M7*
EL	ELECTRONIC LOW VOLTAGE, FORWARD PHASE	INC*	DM	EL
LE	ELECTRONIC LOW VOLTAGE, REVERSE PHASE	INC*	DM*	EL*
MX	ADVANCE MARK-X BALLAST	MX	MX	MX
HL	LUTRON HI-LUME BALLAST	HL*	HL	HL*
TU	LUTRON TU-WIRE BALLAST	TU	MX	MX
MM	MAGNETIC LOW VOLTAGE	LV	LV	LV
ND	NON-DIM (ON/OFF CONTROL ONLY)	ND	ND	ND
CC	CONSTANT (BREAKERS ONLY)	CON	CC	-

- * REQUIRES POWER EXTENDER
- ** REQUIRES POWER EXTENDER FOR MORE THAN 8 PER CONTROL MODULE
- OPTION NOT AVAILABLE



20497 SW Teton Ave.
Tualatin, OR 97062-8812
USA
+1 503.404.5500

PROVIDED BY

PAUL FARRIS

PROJECT PHASE
PRODUCTION

DATE
12-02-2022

SCALE
NONE

DIMENSION

RELEASE

TITLE

SCHEDULES KEY
CHARTS

PROJECT

PENN
CONVENTION
CENTER PANEL
REPLACEMENT

PA

ASAP # -DWG
2244329268-120.0

SHEET
1 OF 1

PANEL NAME: RP4B
 LOCATION:
 PANEL TYPE: GREENMAX 48

R48TC-100 48 SIZE CABINET
 RPM16-316 COMMAND MODULE 16 INPUT LC3

CONTROL POWER:

LOAD CIRCUITS				CONTROL			CIRCUIT			RELAY	CIRCUIT			CONTROL			LOAD CIRCUITS		(EM)	VB	
VB	(EM)	NOTES	WATTS	RELAY TYPE	ZONE	INPUT	LC	PANEL	BRKR	POS	POS	PANEL	BRKR	LC	INPUT	ZONE	RELAY TYPE	WATTS	NOTES	(EM)	VB
N	N		0	1CB			1			1	25			25			1CB	0		N	N
N	N		0	1CB			2			2	26			26			1CB	0		N	N
N	N		0	1CB			3			3	27			27			1CB	0		N	N
N	N		0	1CB			4			4	28			28			1CB	0		N	N
N	N		0	1CB			5			5	29			29			1CB	0		N	N
N	N		0	1CB			6			6	30			30			1CB	0		N	N
N	N		0	1CB			7			7	31			31			1CB	0		N	N
N	N		0	1CB			8			8	32			32			1CB	0		N	N
N	N		0	1CB			9			9	33			33			BFM			N	N
N	N		0	1CB			10			10	34			34			BFM			N	N
N	N		0	1CB			11			11	35			35			BFM			N	N
N	N		0	1CB			12			12	36			36			BFM			N	N
N	N		0	1CB			13			13	37			37			BFM			N	N
N	N		0	1CB			14			14	38			38			BFM			N	N
N	N		0	1CB			15			15	39			39			BFM			N	N
N	N		0	1CB			16			16	40			40			BFM			N	N
N	N		0	1CB			17			17	41			41			BFM			N	N
N	N		0	1CB			18			18	42			42			BFM			N	N
N	N		0	1CB			19			19	43			43			BFM			N	N
N	N		0	1CB			20			20	44			44			BFM			N	N
N	N		0	1CB			21			21	45			45			BFM			N	N
N	N		0	1CB			22			22	46			46			BFM			N	N
N	N		0	1CB			23			23	47			47			BFM			N	N
N	N		0	1CB			24			24	48			48			BFM			N	N

RGBAR-061 VOLTAGE BARRIERS. PLACE ON EITHER SIDE OF INDICATED RELAYS.

32 RELAY-1CB 1 POLE RTC LATCHING
 16 RELAY-BFM RELAY BLANK FILLER MODULE

To be completed by installer for record

RP4B ANALOG / SWITCH INPUT CONNECTION TABLE

INPUT		SWITCH CIRCUIT FUNCTION			
TERMINAL BLOCK	TYPE	DESCRIPTION	ID TYPE	FUNCTION	ACTION TYPE
1					
2					
3					
4					
5					
6					
7					
8					

INPUT		SWITCH CIRCUIT FUNCTION			
TERMINAL BLOCK	TYPE	DESCRIPTION	ID TYPE	FUNCTION	ACTION TYPE
9					
10					
11					
12					
13					
14					
15					
16					



20497 SW Teton Ave.
 Tualatin, OR 97062-8812
 USA
 +1 503.404.5500

PROVIDED BY

PAUL FARRIS

PROJECT PHASE
 PRODUCTION

DATE
 12-02-2022

SCALE
 NONE

DIMENSION

RELEASE

TITLE

SCHEDULES

PROJECT

PENN
 CONVENTION
 CENTER PANEL
 REPLACEMENT

PA

ASAP # -DWG
 2244329268-121.1

SHEET
 1 OF 8

PANEL NAME: RP4C
 LOCATION:
 PANEL TYPE: GREENMAX 32

R32TC-100 32 SIZE CABINET
 RPM16-316 COMMAND MODULE 16 INPUT LC3

CONTROL POWER:

LOAD CIRCUITS				CONTROL			CIRCUIT			RELAY	CIRCUIT			CONTROL			LOAD CIRCUITS			(EM)	VB
VB	(EM)	NOTES	WATTS	RELAY TYPE	ZONE	INPUT	LC	PANEL	BRKR	POS	POS	PANEL	BRKR	LC	INPUT	ZONE	RELAY TYPE	WATTS	NOTES	(EM)	VB
N	N		0	1CB			1			1	17			17			BFM			N	N
N	N		0	1CB			2			2	18			18			BFM			N	N
N	N		0	1CB			3			3	19			19			BFM			N	N
N	N		0	1CB			4			4	20			20			BFM			N	N
N	N		0	1CB			5			5	21			21			BFM			N	N
N	N		0	1CB			6			6	22			22			BFM			N	N
N	N		0	1CB			7			7	23			23			BFM			N	N
N	N		0	1CB			8			8	24			24			BFM			N	N
N	N		0	1CB			9			9	25			25			BFM			N	N
N	N		0	1CB			10			10	26			26			BFM			N	N
N	N		0	1CB			11			11	27			27			BFM			N	N
N	N		0	1CB			12			12	28			28			BFM			N	N
N	N		0	1CB			13			13	29			29			BFM			N	N
N	N		0	1CB			14			14	30			30			BFM			N	N
N	N		0	1CB			15			15	31			31			BFM			N	N
N	N		0	1CB			16			16	32			32			BFM			N	N

RGBAR-061 VOLTAGE BARRIERS. PLACE ON EITHER SIDE OF INDICATED RELAYS.

16 RELAY-1CB 1 POLE RTC LATCHING

16 RELAY-BFM RELAY BLANK FILLER MODULE

To be completed by installer for record

RP4C ANALOG / SWITCH INPUT CONNECTION TABLE

INPUT		SWITCH CIRCUIT FUNCTION			
TERMINAL BLOCK	TYPE	DESCRIPTION	ID TYPE	FUNCTION	ACTION TYPE
1					
2					
3					
4					
5					
6					
7					
8					

INPUT		SWITCH CIRCUIT FUNCTION			
TERMINAL BLOCK	TYPE	DESCRIPTION	ID TYPE	FUNCTION	ACTION TYPE
9					
10					
11					
12					
13					
14					
15					
16					



20497 SW Teton Ave.
 Tualatin, OR 97062-8812
 USA
 +1 503.404.5500

PROVIDED BY

PAUL FARRIS

PROJECT PHASE
 PRODUCTION

DATE
 12-02-2022

SCALE
 NONE

DIMENSION

RELEASE

TITLE

SCHEDULES

PROJECT

PENN
 CONVENTION
 CENTER PANEL
 REPLACEMENT

PA

ASAP # -DWG
 2244329268-121.1

SHEET
 2 OF 8

PANEL NAME: RP4D
 LOCATION:
 PANEL TYPE: GREENMAX 48

R48TC-100 48 SIZE CABINET
 RPM16-316 COMMAND MODULE 16 INPUT LC3

CONTROL POWER:

LOAD CIRCUITS				CONTROL			CIRCUIT			RELAY	CIRCUIT			CONTROL			LOAD CIRCUITS		(EM)	VB	
VB	(EM)	NOTES	WATTS	RELAY TYPE	ZONE	INPUT	LC	PANEL	BRKR	POS	POS	PANEL	BRKR	LC	INPUT	ZONE	RELAY TYPE	WATTS	NOTES	(EM)	VB
N	N		0	1CB			1			1	25			25			1CB	0		N	N
N	N		0	1CB			2			2	26			26			1CB	0		N	N
N	N		0	1CB			3			3	27			27			1CB	0		N	N
N	N		0	1CB			4			4	28			28			1CB	0		N	N
N	N		0	1CB			5			5	29			29			1CB	0		N	N
N	N		0	1CB			6			6	30			30			1CB	0		N	N
N	N		0	1CB			7			7	31			31			1CB	0		N	N
N	N		0	1CB			8			8	32			32			1CB	0		N	N
N	N		0	1CB			9			9	33			33			BFM			N	N
N	N		0	1CB			10			10	34			34			BFM			N	N
N	N		0	1CB			11			11	35			35			BFM			N	N
N	N		0	1CB			12			12	36			36			BFM			N	N
N	N		0	1CB			13			13	37			37			BFM			N	N
N	N		0	1CB			14			14	38			38			BFM			N	N
N	N		0	1CB			15			15	39			39			BFM			N	N
N	N		0	1CB			16			16	40			40			BFM			N	N
N	N		0	1CB			17			17	41			41			BFM			N	N
N	N		0	1CB			18			18	42			42			BFM			N	N
N	N		0	1CB			19			19	43			43			BFM			N	N
N	N		0	1CB			20			20	44			44			BFM			N	N
N	N		0	1CB			21			21	45			45			BFM			N	N
N	N		0	1CB			22			22	46			46			BFM			N	N
N	N		0	1CB			23			23	47			47			BFM			N	N
N	N		0	1CB			24			24	48			48			BFM			N	N

RGBAR-061 VOLTAGE BARRIERS. PLACE ON EITHER SIDE OF INDICATED RELAYS.

32 RELAY-1CB 1 POLE RTC LATCHING
 16 RELAY-BFM RELAY BLANK FILLER MODULE

To be completed by installer for record

RP4D ANALOG / SWITCH INPUT CONNECTION TABLE

INPUT		SWITCH CIRCUIT FUNCTION			
TERMINAL BLOCK	TYPE	DESCRIPTION	ID TYPE	FUNCTION	ACTION TYPE
1					
2					
3					
4					
5					
6					
7					
8					

INPUT		SWITCH CIRCUIT FUNCTION			
TERMINAL BLOCK	TYPE	DESCRIPTION	ID TYPE	FUNCTION	ACTION TYPE
9					
10					
11					
12					
13					
14					
15					
16					



20497 SW Teton Ave.
 Tualatin, OR 97062-8812
 USA
 +1 503.404.5500

PROVIDED BY

PAUL FARRIS

PROJECT PHASE
 PRODUCTION

DATE
 12-02-2022

SCALE
 NONE

DIMENSION

RELEASE

TITLE

SCHEDULES

PROJECT

PENN
 CONVENTION
 CENTER PANEL
 REPLACEMENT

PA

ASAP # -DWG
 2244329268-121.1

SHEET
 3 OF 8

PANEL NAME: RP4E
 LOCATION:
 PANEL TYPE: GREENMAX 48

R48TC-100 48 SIZE CABINET
 RPM16-316 COMMAND MODULE 16 INPUT LC3

CONTROL POWER:

LOAD CIRCUITS				CONTROL			CIRCUIT			RELAY	CIRCUIT			CONTROL			LOAD CIRCUITS		(EM)	VB	
VB	(EM)	NOTES	WATTS	RELAY TYPE	ZONE	INPUT	LC	PANEL	BRKR	POS	POS	PANEL	BRKR	LC	INPUT	ZONE	RELAY TYPE	WATTS	NOTES	(EM)	VB
N	N		0	1CB			1			1	25			25			1CB	0		N	N
N	N		0	1CB			2			2	26			26			1CB	0		N	N
N	N		0	1CB			3			3	27			27			1CB	0		N	N
N	N		0	1CB			4			4	28			28			1CB	0		N	N
N	N		0	1CB			5			5	29			29			1CB	0		N	N
N	N		0	1CB			6			6	30			30			1CB	0		N	N
N	N		0	1CB			7			7	31			31			1CB	0		N	N
N	N		0	1CB			8			8	32			32			1CB	0		N	N
N	N		0	1CB			9			9	33			33			BFM			N	N
N	N		0	1CB			10			10	34			34			BFM			N	N
N	N		0	1CB			11			11	35			35			BFM			N	N
N	N		0	1CB			12			12	36			36			BFM			N	N
N	N		0	1CB			13			13	37			37			BFM			N	N
N	N		0	1CB			14			14	38			38			BFM			N	N
N	N		0	1CB			15			15	39			39			BFM			N	N
N	N		0	1CB			16			16	40			40			BFM			N	N
N	N		0	1CB			17			17	41			41			BFM			N	N
N	N		0	1CB			18			18	42			42			BFM			N	N
N	N		0	1CB			19			19	43			43			BFM			N	N
N	N		0	1CB			20			20	44			44			BFM			N	N
N	N		0	1CB			21			21	45			45			BFM			N	N
N	N		0	1CB			22			22	46			46			BFM			N	N
N	N		0	1CB			23			23	47			47			BFM			N	N
N	N		0	1CB			24			24	48			48			BFM			N	N

RGBAR-061 VOLTAGE BARRIERS. PLACE ON EITHER SIDE OF INDICATED RELAYS.

32 RELAY-1CB 1 POLE RTC LATCHING
 16 RELAY-BFM RELAY BLANK FILLER MODULE

To be completed by installer for record

RP4E ANALOG / SWITCH INPUT CONNECTION TABLE

INPUT		SWITCH CIRCUIT FUNCTION			
TERMINAL BLOCK	TYPE	DESCRIPTION	ID TYPE	FUNCTION	ACTION TYPE
1					
2					
3					
4					
5					
6					
7					
8					

INPUT		SWITCH CIRCUIT FUNCTION			
TERMINAL BLOCK	TYPE	DESCRIPTION	ID TYPE	FUNCTION	ACTION TYPE
9					
10					
11					
12					
13					
14					
15					
16					



20497 SW Teton Ave.
 Tualatin, OR 97062-8812
 USA
 +1 503.404.5500

PROVIDED BY

PAUL FARRIS

PROJECT PHASE
 PRODUCTION

DATE
 12-02-2022

SCALE
 NONE

DIMENSION

RELEASE

TITLE

SCHEDULES

PROJECT

PENN
 CONVENTION
 CENTER PANEL
 REPLACEMENT

PA

ASAP # -DWG
 2244329268-121.1

SHEET
 4 OF 8

PANEL NAME: RP4F
 LOCATION:
 PANEL TYPE: GREENMAX 48

R48TC-100 48 SIZE CABINET
 RPM16-316 COMMAND MODULE 16 INPUT LC3

CONTROL POWER:

LOAD CIRCUITS				CONTROL			CIRCUIT			RELAY	CIRCUIT			CONTROL			LOAD CIRCUITS		(EM)	VB	
VB	(EM)	NOTES	WATTS	RELAY TYPE	ZONE	INPUT	LC	PANEL	BRKR	POS	POS	PANEL	BRKR	LC	INPUT	ZONE	RELAY TYPE	WATTS	NOTES	(EM)	VB
N	N		0	1CB			1			1	25			25			1CB	0		N	N
N	N		0	1CB			2			2	26			26			1CB	0		N	N
N	N		0	1CB			3			3	27			27			1CB	0		N	N
N	N		0	1CB			4			4	28			28			1CB	0		N	N
N	N		0	1CB			5			5	29			29			1CB	0		N	N
N	N		0	1CB			6			6	30			30			1CB	0		N	N
N	N		0	1CB			7			7	31			31			1CB	0		N	N
N	N		0	1CB			8			8	32			32			1CB	0		N	N
N	N		0	1CB			9			9	33			33			BFM			N	N
N	N		0	1CB			10			10	34			34			BFM			N	N
N	N		0	1CB			11			11	35			35			BFM			N	N
N	N		0	1CB			12			12	36			36			BFM			N	N
N	N		0	1CB			13			13	37			37			BFM			N	N
N	N		0	1CB			14			14	38			38			BFM			N	N
N	N		0	1CB			15			15	39			39			BFM			N	N
N	N		0	1CB			16			16	40			40			BFM			N	N
N	N		0	1CB			17			17	41			41			BFM			N	N
N	N		0	1CB			18			18	42			42			BFM			N	N
N	N		0	1CB			19			19	43			43			BFM			N	N
N	N		0	1CB			20			20	44			44			BFM			N	N
N	N		0	1CB			21			21	45			45			BFM			N	N
N	N		0	1CB			22			22	46			46			BFM			N	N
N	N		0	1CB			23			23	47			47			BFM			N	N
N	N		0	1CB			24			24	48			48			BFM			N	N

RGBAR-061 VOLTAGE BARRIERS. PLACE ON EITHER SIDE OF INDICATED RELAYS.

32 RELAY-1CB 1 POLE RTC LATCHING
 16 RELAY-BFM RELAY BLANK FILLER MODULE

To be completed by installer for record

RP4F ANALOG / SWITCH INPUT CONNECTION TABLE

INPUT		SWITCH CIRCUIT FUNCTION			
TERMINAL BLOCK	TYPE	DESCRIPTION	ID TYPE	FUNCTION	ACTION TYPE
1					
2					
3					
4					
5					
6					
7					
8					

INPUT		SWITCH CIRCUIT FUNCTION			
TERMINAL BLOCK	TYPE	DESCRIPTION	ID TYPE	FUNCTION	ACTION TYPE
9					
10					
11					
12					
13					
14					
15					
16					



20497 SW Teton Ave.
 Tualatin, OR 97062-8812
 USA
 +1 503.404.5500

PROVIDED BY

PAUL FARRIS

PROJECT PHASE
 PRODUCTION

DATE
 12-02-2022

SCALE
 NONE

DIMENSION

RELEASE

TITLE

SCHEDULES

PROJECT

PENN
 CONVENTION
 CENTER PANEL
 REPLACEMENT

PA

ASAP # -DWG
 2244329268-121.1

SHEET
 5 OF 8

PANEL NAME: RP4G
 LOCATION:
 PANEL TYPE: GREENMAX 32

R32TC-100 32 SIZE CABINET
 RPM16-316 COMMAND MODULE 16 INPUT LC3

CONTROL POWER:

LOAD CIRCUITS				CONTROL			CIRCUIT			RELAY	CIRCUIT			CONTROL			LOAD CIRCUITS			(EM)	VB
VB	(EM)	NOTES	WATTS	RELAY TYPE	ZONE	INPUT	LC	PANEL	BRKR	POS	POS	PANEL	BRKR	LC	INPUT	ZONE	RELAY TYPE	WATTS	NOTES	(EM)	VB
N	N		0	1CB			1			1	17			17			1CB	0		N	N
N	N		0	1CB			2			2	18			18			1CB	0		N	N
N	N		0	1CB			3			3	19			19			1CB	0		N	N
N	N		0	1CB			4			4	20			20			BFM			N	N
N	N		0	1CB			5			5	21			21			BFM			N	N
N	N		0	1CB			6			6	22			22			BFM			N	N
N	N		0	1CB			7			7	23			23			BFM			N	N
N	N		0	1CB			8			8	24			24			BFM			N	N
N	N		0	1CB			9			9	25			25			BFM			N	N
N	N		0	1CB			10			10	26			26			BFM			N	N
N	N		0	1CB			11			11	27			27			BFM			N	N
N	N		0	1CB			12			12	28			28			BFM			N	N
N	N		0	1CB			13			13	29			29			BFM			N	N
N	N		0	1CB			14			14	30			30			BFM			N	N
N	N		0	1CB			15			15	31			31			BFM			N	N
N	N		0	1CB			16			16	32			32			BFM			N	N

RGBAR-061 VOLTAGE BARRIERS. PLACE ON EITHER SIDE OF INDICATED RELAYS.

19 RELAY-1CB 1 POLE RTC LATCHING

13 RELAY-BFM RELAY BLANK FILLER MODULE

To be completed by installer for record

RP4G ANALOG / SWITCH INPUT CONNECTION TABLE

INPUT		SWITCH CIRCUIT FUNCTION			
TERMINAL BLOCK	TYPE	DESCRIPTION	ID TYPE	FUNCTION	ACTION TYPE
1					
2					
3					
4					
5					
6					
7					
8					

INPUT		SWITCH CIRCUIT FUNCTION			
TERMINAL BLOCK	TYPE	DESCRIPTION	ID TYPE	FUNCTION	ACTION TYPE
9					
10					
11					
12					
13					
14					
15					
16					



20497 SW Teton Ave.
 Tualatin, OR 97062-8812
 USA
 +1 503.404.5500

PROVIDED BY

PAUL FARRIS

PROJECT PHASE
 PRODUCTION

DATE
 12-02-2022

SCALE
 NONE

DIMENSION

RELEASE

TITLE

SCHEDULES

PROJECT

PENN
 CONVENTION
 CENTER PANEL
 REPLACEMENT

PA

ASAP # -DWG
 2244329268-121.1

SHEET
 6 OF 8

PANEL NAME: RP3A
 LOCATION:
 PANEL TYPE: GREENMAX 48

R48TC-100 48 SIZE CABINET
 RPM16-316 COMMAND MODULE 16 INPUT LC3

CONTROL POWER:

LOAD CIRCUITS				CONTROL			CIRCUIT			RELAY	CIRCUIT			CONTROL			LOAD CIRCUITS				
VB	(EM)	NOTES	WATTS	RELAY TYPE	ZONE	INPUT	LC	PANEL	BRKR	POS	POS	PANEL	BRKR	LC	INPUT	ZONE	RELAY TYPE	WATTS	NOTES	(EM)	VB
N	N		0	1CB			1			1	25			25			1CB	0		N	N
N	N		0	1CB			2			2	26			26			1CB	0		N	N
N	N		0	1CB			3			3	27			27			1CB	0		N	N
N	N		0	1CB			4			4	28			28			1CB	0		N	N
N	N		0	1CB			5			5	29			29			1CB	0		N	N
N	N		0	1CB			6			6	30			30			1CB	0		N	N
N	N		0	1CB			7			7	31			31			1CB	0		N	N
N	N		0	1CB			8			8	32			32			1CB	0		N	N
N	N		0	1CB			9			9	33			33			BFM			N	N
N	N		0	1CB			10			10	34			34			BFM			N	N
N	N		0	1CB			11			11	35			35			BFM			N	N
N	N		0	1CB			12			12	36			36			BFM			N	N
N	N		0	1CB			13			13	37			37			BFM			N	N
N	N		0	1CB			14			14	38			38			BFM			N	N
N	N		0	1CB			15			15	39			39			BFM			N	N
N	N		0	1CB			16			16	40			40			BFM			N	N
N	N		0	1CB			17			17	41			41			BFM			N	N
N	N		0	1CB			18			18	42			42			BFM			N	N
N	N		0	1CB			19			19	43			43			BFM			N	N
N	N		0	1CB			20			20	44			44			BFM			N	N
N	N		0	1CB			21			21	45			45			BFM			N	N
N	N		0	1CB			22			22	46			46			BFM			N	N
N	N		0	1CB			23			23	47			47			BFM			N	N
N	N		0	1CB			24			24	48			48			BFM			N	N

RGBAR-061 VOLTAGE BARRIERS. PLACE ON EITHER SIDE OF INDICATED RELAYS.

32 RELAY-1CB 1 POLE RTC LATCHING
 16 RELAY-BFM RELAY BLANK FILLER MODULE

To be completed by installer for record

RP3A ANALOG / SWITCH INPUT CONNECTION TABLE

INPUT		SWITCH CIRCUIT FUNCTION			
TERMINAL BLOCK	TYPE	DESCRIPTION	ID TYPE	FUNCTION	ACTION TYPE
1					
2					
3					
4					
5					
6					
7					
8					

INPUT		SWITCH CIRCUIT FUNCTION			
TERMINAL BLOCK	TYPE	DESCRIPTION	ID TYPE	FUNCTION	ACTION TYPE
9					
10					
11					
12					
13					
14					
15					
16					



20497 SW Teton Ave.
 Tualatin, OR 97062-8812
 USA
 +1 503.404.5500

PROVIDED BY

PAUL FARRIS

PROJECT PHASE
 PRODUCTION

DATE
 12-02-2022

SCALE
 NONE

DIMENSION

RELEASE

TITLE

SCHEDULES

PROJECT

PENN
 CONVENTION
 CENTER PANEL
 REPLACEMENT

PA

ASAP # -DWG
 2244329268-121.1

SHEET
 7 OF 8

PANEL NAME: RP4A
 LOCATION:
 PANEL TYPE: GREENMAX 48

R48TC-100 48 SIZE CABINET
 RPM16-316 COMMAND MODULE 16 INPUT LC3

CONTROL POWER:

LOAD CIRCUITS				CONTROL			CIRCUIT			RELAY	CIRCUIT			CONTROL			LOAD CIRCUITS		(EM)	VB	
VB	(EM)	NOTES	WATTS	RELAY TYPE	ZONE	INPUT	LC	PANEL	BRKR	POS	POS	PANEL	BRKR	LC	INPUT	ZONE	RELAY TYPE	WATTS	NOTES	(EM)	VB
N	N		0	1CB			1			1	25			25			1CB	0		N	N
N	N		0	1CB			2			2	26			26			1CB	0		N	N
N	N		0	1CB			3			3	27			27			1CB	0		N	N
N	N		0	1CB			4			4	28			28			1CB	0		N	N
N	N		0	1CB			5			5	29			29			1CB	0		N	N
N	N		0	1CB			6			6	30			30			1CB	0		N	N
N	N		0	1CB			7			7	31			31			1CB	0		N	N
N	N		0	1CB			8			8	32			32			1CB	0		N	N
N	N		0	1CB			9			9	33			33			BFM			N	N
N	N		0	1CB			10			10	34			34			BFM			N	N
N	N		0	1CB			11			11	35			35			BFM			N	N
N	N		0	1CB			12			12	36			36			BFM			N	N
N	N		0	1CB			13			13	37			37			BFM			N	N
N	N		0	1CB			14			14	38			38			BFM			N	N
N	N		0	1CB			15			15	39			39			BFM			N	N
N	N		0	1CB			16			16	40			40			BFM			N	N
N	N		0	1CB			17			17	41			41			BFM			N	N
N	N		0	1CB			18			18	42			42			BFM			N	N
N	N		0	1CB			19			19	43			43			BFM			N	N
N	N		0	1CB			20			20	44			44			BFM			N	N
N	N		0	1CB			21			21	45			45			BFM			N	N
N	N		0	1CB			22			22	46			46			BFM			N	N
N	N		0	1CB			23			23	47			47			BFM			N	N
N	N		0	1CB			24			24	48			48			BFM			N	N

RGBAR-061 VOLTAGE BARRIERS. PLACE ON EITHER SIDE OF INDICATED RELAYS.

32 RELAY-1CB 1 POLE RTC LATCHING
 16 RELAY-BFM RELAY BLANK FILLER MODULE

To be completed by installer for record

RP4A ANALOG / SWITCH INPUT CONNECTION TABLE

INPUT		SWITCH CIRCUIT FUNCTION			
TERMINAL BLOCK	TYPE	DESCRIPTION	ID TYPE	FUNCTION	ACTION TYPE
1					
2					
3					
4					
5					
6					
7					
8					

INPUT		SWITCH CIRCUIT FUNCTION			
TERMINAL BLOCK	TYPE	DESCRIPTION	ID TYPE	FUNCTION	ACTION TYPE
9					
10					
11					
12					
13					
14					
15					
16					



20497 SW Teton Ave.
 Tualatin, OR 97062-8812
 USA
 +1 503.404.5500

PROVIDED BY

PAUL FARRIS

PROJECT PHASE
 PRODUCTION

DATE
 12-02-2022

SCALE
 NONE

DIMENSION

RELEASE

TITLE

SCHEDULES

PROJECT

PENN
 CONVENTION
 CENTER PANEL
 REPLACEMENT

PA

ASAP # -DWG
 2244329268-121.1

SHEET
 8 OF 8

GreenMAX[®] Relay Modules

Offers Latching, Dimming and Daylight Harvesting Capabilities



- 25,000A Short Circuit Current Rating (SCCR) at 277VAC
- Rated at 30A General Fluorescent Ballast and 20A Incandescent, HID, Electronic Ballast
- All Models are Latching Relays with Manual Actuator
- Exclusive 0-10VDC (sinking) Dimming Relay Module for Daylight Harvesting for compatible Fluorescent and LED drivers
- CA Title 24 2013 Compliant and Listed

The Leviton line of GreenMAX[®] Relay Modules offers features and performance not available from any competing product on the market today. For increased reliability and durability, GreenMAX Relay Modules have a 25,000A Short Circuit Current Rating (SCCR) at 277VAC. All GreenMAX Relay Modules are 1-pole or 2-pole latching relay types that reduce parasitic energy use. All relay modules are the same physical size, allowing the optimal mix of relays to be customized for each application. Models include a basic control relay module, a Return To Closed relay module, and a self-contained 0-10VDC (sinking) dimming relay module that features daylight harvesting capabilities.

All relays must be used in a GreenMAX system cabinet.

APPLICATIONS

- Heavy retrofit applications
- New construction projects
- Government facilities
- Office buildings
- Hospitals/medical offices
- Universities
- Restaurants
- Large campuses
- Any other location requiring Daylight Harvesting and Demand Response

FEATURES

- All GreenMAX relay modules have a 25,000A at 277VAC Short Circuit Current Rating (SCCR) for increased reliability and durability
- Rated at 30A general fluorescent ballast and 20A incandescent for all GreenMAX relays
- All relays are latching with a manual actuator to reduce parasitic energy waste over NO/NC relays
- Manual actuation lever on all GreenMAX relays allow users to manually turn lights ON or OFF without a CPU or power
- No exposed printed circuit boards or components. The encased plastic housing provides the perimeter of safety. Wire terminations are safely contained within the plastic housing. Wires connect directly to terminators rather than terminals that are soldered to a circuit board, which are prone to breaking connections to the board
- Self-contained 20A, 0-10VDC (sinking) Dimming relay module in 1-pole configurations features daylight harvesting capabilities
- Conductors for the 20A, 0-10VDC (sinking) Dimming relay circuit must be run in the Line and Load conductor area in the GreenMAX cabinet. The insulation of these conductors must be in compliance with all applicable electrical codes. The NEC will allow this condition if the insulation of the low voltage wires is rated for the highest voltage available in the compartment

GreenMAX[®] Relay Modules

<p>Lighting & Controls 10385 SW AVERY ST TUALATIN, OR 97062 (503) 404-5500 http://www.leviton.com</p>	PROJECT: Penn Convention Center Panel Replacement		
	TITLE: Product Cut Sheets	QUOTE: 2244329268	LOCATION: Philadelphia
	REVISION: 1	DATE: 12-02-2022	
	PREPARED BY: Paul Farris		COMPANY PHONE:

SPECIFICATIONS

Environmental

- Ambient Temperature Range: 32°F - 122°F (0°C - 50°C)
- Relative Humidity: < 90% non-condensing

Listings

- UL916, UL508, UL924, cUL, CA Title 24 2013 Compliant and Listed, ASHRAE 90.1 compliant

Warranty

- Relay Modules backed by 10-year warranty

ORDERING INFORMATION

CAT. NO.	DESCRIPTION	LOAD RATINGS
SINGLE POLE RELAYS		
RELAY-1CB	Return to Closed (RTC) Latching Relay	24-277VAC, 347VAC, 20A Tungsten Halogen Incandescent, 20A Electronic Ballast and HID 24-277VAC, 347VAC, 30A Magnetic Ballast, 20A Electronic Ballast, 120VAC 1/2 Hp Motor, 277VAC 1 Hp Motor, 240VAC 1Hp Motor Wire Range: #14 - #6 AWG Copper, Torque 16 in.-lbs. 25,000A SCCR Rating at 277VAC
RELAY-1TB	Latching Relay	24-277VAC, 347VAC, 20A Tungsten Halogen Incandescent, 20A Electronic Ballast and HID 24-277VAC, 347VAC, 30A Magnetic Ballast, 20A Electronic Ballast, 120VAC 1/2 Hp Motor, 277VAC 1 Hp Motor, 240VAC 1Hp Motor Wire Range: #14 - #6 AWG Copper, Torque 16 in.-lbs. 25,000A SCCR Rating at 277VAC
RELAY-1DS	Dimming and Switching Latching Relay	24-277VAC, 347VAC, 20A 0-10V (sinking) Dimming Fluorescent and LED Driver Wire Range #14 - #6 AWG Copper, Torque 16 in.-lbs. Control Wire Range: #14 - 12 AWG Copper, Torque 14 in.-lbs. Maximum 0-10VDC (sinking) Dimming control circuit load: 200mA 25,000A SCCR Rating at 277VAC
DOUBLE POLE RELAYS		
RELAY-2CB	Return to Closed (RTC) Latching Relay	208/240/480/600VAC, 20A Tungsten Halogen Incandescent, 20A Electronic Ballast and HID 208/240/480/600, 30A Magnetic Ballast, 20A Magnetic Ballast, 208/240VAC 1Hp Motor Wire Range: #14 - #6 AWG Copper, Torque 16 in.-lbs.
RELAY-2TB	Latching Relay	208/240/480/600VAC, 20A Tungsten Halogen Incandescent, 20A Electronic Ballast and HID 208/240/480/600, 30A Magnetic Ballast, 20A Magnetic Ballast, 208/240VAC 1Hp Motor Wire Range: #14 - #6 AWG Copper, Torque 16 in.-lbs.
RELAY-BFM	Blank Filler Module	-

GreenMAX® Relay Modules

WIRING DIAGRAM

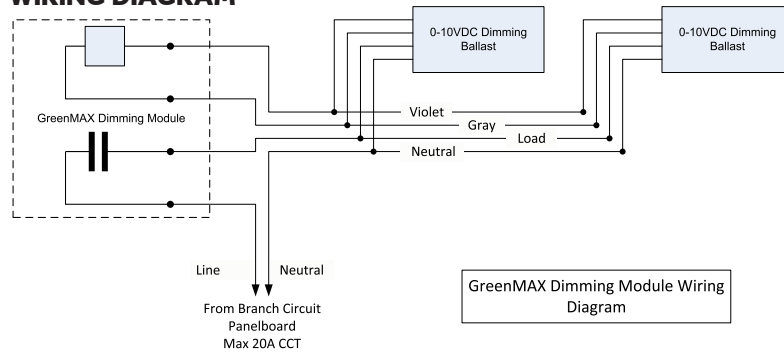

<p>Lighting & Controls 10385 SW AVERY ST TUALATIN, OR 97062 (503) 404-5500 http://www.leviton.com</p>	PROJECT: Penn Convention Center Panel Replacement		
	TITLE: Product Cut Sheets	QUOTE: 2244329268	LOCATION: Philadelphia
	REVISION: 1	DATE: 12-02-2022	
	PREPARED BY: Paul Farris		COMPANY PHONE:

GreenMAX[®] Relay Control Panels

Modular Relay System Offers Unparalleled Flexibility



GreenMAX Cabinet

- Cabinets and Relay Modules with 25,000A Short Circuit Current Rating (SCCR) at 277VAC
- Relay Modules Rated at 30A General Fluorescent Ballast and 20A Incandescent
- Relay Modules are Latching with Manual Actuator
- Industry standard 0-10V Dimming and Switching Relay Module
- Programming and Monitoring of the System is done with the Exclusive Handheld Display Unit (HDU)
- Empty Enclosure Ships Separately From Electrical Components
- Supports Native Protocols of BACnet/IP, Ethernet, and LumaCAN
- 8, 16, 32 and 48 Relay Sizes
- Four programmable levels of Demand Response
- CA Title 24 2013 Compliant and Listed

The Leviton GreenMAX[®] Relay Control Panels line offers features and performance not available from any competing product on the market today. For increased reliability and durability, GreenMAX Cabinets and Relay Modules have a 25,000A Short Circuit Current Rating (SCCR) at 277VAC. Native communication network protocols - BACnet/IP, Ethernet, and LumaCAN - are built into each GreenMAX Command Module (processor) to offer unparalleled connectivity. No additional parts or adapters are needed to communicate with other products utilizing these protocols.

For increased flexibility, the modular GreenMAX system includes separate Cabinet enclosures, Command Modules (processor, power supply, and low voltage inputs), Relay Insert Panels, Relay Modules, and a Handheld Display Unit (HDU). For easier manageability and accessibility, Leviton ships empty cabinet enclosures separately from the electronic components. This makes the cabinets lighter and easier to handle and requires less effort to install. To further minimize handling and damage to the electronic components, Leviton can ship the electronic components later in the project schedule or as required.

All GreenMAX Relay Modules are 1-pole or 2-pole latching relay types that reduce parasitic energy use. The relay modules are the same

physical size, allowing the optimal mix of relays to be customized for each application. Models include a basic control relay module and/or a self-contained dimming and switching relay module that supports daylight harvesting capabilities.

A Handheld Display Unit (HDU) can be detached from the cabinet mounting location and moved to the most convenient network connection point to connect to any open LumaCAN or port on the same network as the cabinets. Commissioning and start-up functions are easier with the HDU, which allows programming to be done in the space being controlled rather than from the electrical room.

APPLICATIONS

- Heavy retrofit applications
- New construction projects
- Government facilities
- Office buildings
- Hospitals/medical offices
- Universities
- Restaurants
- Large campuses
- Any location requiring Daylight Harvesting and Demand Response

GreenMAX[®] Relay Control Panels

<p>Lighting & Controls 10385 SW AVERY ST TUALATIN, OR 97062 (503) 404-5500 http://www.leviton.com</p>	PROJECT: Penn Convention Center Panel Replacement		
	TITLE: Product Cut Sheets	QUOTE: 2244329268	LOCATION: Philadelphia
	REVISION: 1	DATE: 12-02-2022	
	PREPARED BY: Paul Farris		COMPANY PHONE:

PRODUCT DATA

FEATURES

Relay Cabinet

- GreenMAX cabinet has a 25,000A at 277VAC Short Circuit Current Rating (SCCR) for increased reliability and durability
- Modular system includes separate empty cabinet enclosures, a command module, and relay insert panels to minimize handling and subsequent damage during installation
 - Command Module is the processor and power supply of the GreenMAX system and optionally includes a low voltage remote input card for analog devices
 - Relay insert panels feature quick install; each panel takes only two screws to install
- Native communication network protocols - BACnet/IP, Ethernet, and LumaCAN - are built into each command module to offer unparalleled connectivity; no additional devices are needed to communicate with other products utilizing these protocols
- Increased arc flash protection - the cabinet door opens to expose only the low voltage area of the cabinet
 - High voltage areas can be accessed by removing the wire-way covers - this requires the removal of retaining screws
- Voltage barriers can be installed between individual relay modules. This allows voltages from mixed sources in the same cabinet

Relay Modules

- All GreenMAX relay modules have a 25,000A Short Circuit Current Rating (SCCR) at 277V for increased reliability and durability
- Rated at 30A general fluorescent ballast (this rating is 20A, 347V in Canada) and 20A incandescent for all GreenMAX relays
- All relays are latching with a manual actuator to reduce parasitic energy waste over NO/NC relays
- Manual actuation lever on all GreenMAX relays allow users to manually bypass the system to turn lights on or off without a CPU or power



GreenMAX Relay Modules

- Self-contained dimming and switching relay module in 1-pole configurations supports daylight harvesting capabilities

Remote Low Voltage Cabinet (RLV)

- Remote low voltage input cabinets can be installed closer to the devices they serve (such as occupancy sensors, LV switches and photocells) to reduce wiring and labor and provide additional power; this also makes commissioning and troubleshooting easier
- Additional Low Voltage input points are available in quantities of 8 and 16
- Power Supply Input: 70W (max), 100-277VAC single phase input, 24VDC output
- The RLV utilizes Cat6 network cable to interconnect with the system and communicates via LumaCan

Handheld Display Unit (HDU)

- Manage the GreenMAX system(s) remotely from any network device location
- System configuration and scheduling is performed via the HDU - this can be done while standing in the room or controlled space; programming is no longer confined to the electrical room
- Control entire GreenMAX system from any access point - relay cabinets, switches, or remote low voltage cabinets
- One HDU can be used for multiple systems
- Can be stored in the cabinet or designated docking station
- Communicate via LumaCAN
- 7 hour run time on a single full charge (batteries included)
- Astronomical clock - sunrise/sunset
- HDU does not need to be connected to system during operation. Full system functionality is provided independent of HDU

*Pair GreenMAX Relay Control Panels, GreenMAX Relay Modules and GreenMAX HDU with GreenMAX Digital Switches and Leviton low voltage switches for a complete lighting control strategy



GreenMAX Handheld Display Unit (HDU)

Comes Complete with four (4) AAA rechargeable Ni-MH batteries. Batteries charge when connected to lumacan



Lighting & Controls
10385 SW AVERY ST
TUALATIN, OR 97062
(503) 404-5500
<http://www.leviton.com>

PROJECT: Penn Convention Center Panel Replacement

TITLE: Product Cut Sheets

QUOTE: 2244329268

LOCATION: Philadelphia

REVISION: 1

DATE: 12-02-2022

PREPARED BY: Paul Farris

COMPANY PHONE:

DIMENSIONS

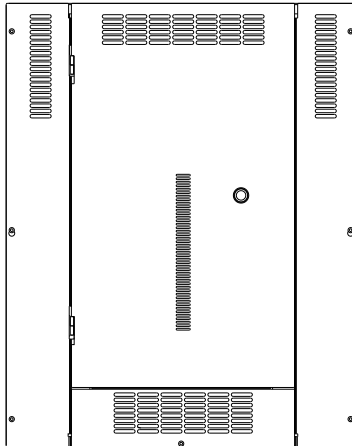

RELAY CABINETS	WIDTH	HEIGHT	DEPTH
R08TC-100	21"	22"	4"
R16TC-100	25"	32"	4"
R32TC-100	25"	48"	4"
R48TC-100	25"	64"	4"
REMOTE LOW VOLTAGE CABINETS			
RLVo8-308	14"	10"	4"
RLV16-316	14"	10"	4"

SPECIFICATIONS

Electrical

- Power Supply Input: 70W (max), 100-277VAC single phase input, 24VDC output
- All Input Voltages: 50/60Hz Phase to Neutral
- Non-volatile memory and micro SD card protect programming during blackouts

Wiring

- Internal: factory pre-wired and tested
- System Communications:
 - LumaCAN requires standard CAT6 network cabling
 - Low voltage Class 2 wiring connects input cards to control devices such as occupancy sensors, low voltage switches, and photocells
 - Hard-wired dedicated Emergency input is provided in each cabinet and requires an external normally open (N/O) contact closure; the Cabinet provides the source of low voltage +24VDC for this circuit; programmable individual relay response to the Emergency signal
- Line Voltage:
 - Feed for Command Module (control electronics) and load wiring only
 - Requires single phase hot and neutral connection
- LumaCAN Network:
 - Cat 6 cable
 - RJ45 connectors
 - Wiring configuration (EIA/TIA 568B)
- Power must be injected into LumaCAN cable every 900 feet
 - Use a Remote Low Voltage Cabinet or a Relay Cabinet
 - Power supply - two-sided allowing up to 1500mA per side

- Voltage barriers available to separate circuits of different sources
 - Voltage barriers field install between Relay Modules

Network Connections

- Maximum LumaCAN communication network segment length is 1600 feet from end of line termination to end of line termination. Longer network lengths can be achieved with the use of a LumaCAN repeater
- Ethernet connectivity is native to each Command Module
 - Ethernet can be used to connect BACnet/IP system
 - Ethernet can be used to bridge between runs of LumaCAN to extend network length
- BACnet/IP is native to each Command Module
 - BACnet/IP must be run to each cabinet - may require Ethernet/Network switch

Physical

- Enclosure: NEMA type 1, IP-20 protection; #16 US gauge steel; indoors only
- Mounting: surface or flush mount

Environmental

- Ambient Temperature Range: 32°F - 122°F (0°C - 50°C)
- Relative Humidity: < 90% non-condensing

Listings

- UL508, UL924, cUL, CA 2013 Title 24 compliant and listed, ASHRAE 90.1 compliant

Warranty

- Relay Modules backed by 10-year warranty
- Relay Panels backed by 2-year warranty

*ARRA compliant panels available - consult factory for availability

<p>Lighting & Controls 10385 SW AVERY ST TUALATIN, OR 97062 (503) 404-5500 http://www.leviton.com</p>	PROJECT: Penn Convention Center Panel Replacement		
	TITLE: Product Cut Sheets	QUOTE: 2244329268	LOCATION: Philadelphia
	REVISION: 1	DATE: 12-02-2022	
	PREPARED BY: Paul Farris		COMPANY PHONE:

ORDERING INFORMATION

CAT. NO.	DESCRIPTION
Enclosures (all cabinets are surface mount with a locking door)	
R08TC-100	GreenMAX Relay Cabinet, 8-Relay Size, NEMA 1
R16TC-100	GreenMAX Relay Cabinet, 16-Relay Size, NEMA 1
R32TC-100	GreenMAX Relay Cabinet, 32-Relay Size, NEMA 1
R48TC-100	GreenMAX Relay Cabinet, 48-Relay Size, NEMA 1
Command Modules (includes power supply with main processor unit), option 24VDC Low Voltage Input Card	
RPM00-300	Main Command Module, 100-277VAC, 50/60Hz, no inputs, LumaCAN3
RPM08-308	Main Command Module with 8-Port Low Voltage Input Card, 100-277VAC, 50/60Hz, LumaCAN3
RPM16-316	Main Command Module with 16-Port Low Voltage Input Card, 100-277VAC, 50/60Hz, LumaCAN3
Panel Interiors	
R0800-000	Relay Insert Panel, Empty with (8) Empty Spaces
R1600-000	Relay Insert Panel, Empty with (16) Empty Spaces
R1616-1CB	Relay Insert Panel with (16) 1-Pole RTC Basic Relays
R1616-1DS	Relay Insert Panel with (16) 1-Pole Dimming and Switching Relays
R1616-1TB	Relay Insert Panel with (16) 1-Pole Basic Relays
R1616-2CB	Relay Insert Panel with (16) 2-Pole RTC Relays
R1616-2TB	Relay Insert Panel with (16) 2-Pole Basic Relays

CAT. NO.	DESCRIPTION
Handheld Display Unit (HDU)	
RHDU1-300	Handheld Display Unit, Cabinet Mounting, LumaCAN3
RHDU1-BKT	Handheld Display Unit, Mounting Bracket
Remote Inputs with Power Supply (all cabinet power supplies are rated 120-277VAC, 50/60HZ)	
RLV08-308	Remote Low Voltage Input Cabinet, 8 Inputs, NEMA 1 Enclosure, LumaCAN3
RLV16-316	Remote Low Voltage Input Cabinet, 16 Inputs, NEMA 1 Enclosure, LumaCAN3
Relays (all relays are rated 30A, 120-230-277/347VAC, 50/60Hz) See GreenMAX Relay Data Sheet for complete ratings	
RELAY-1CB	GreenMAX Latching Relay, 1-Pole RTC Basic
RELAY-1DS	GreenMAX Latching Relay, 1-Pole, Dimming and Switching, 0-10Vdc Dimming, sinking
RELAY-1TB	GreenMAX Latching Relay, 1-Pole Basic
RELAY-2CB	GreenMAX Latching Relay, 2-Pole RTC
RELAY-2TB	GreenMAX Latching Relay, 2-Pole Basic
RELAY-BFM	Blank Filler Module
Cabinet Accessories	
RGBAR-008	GreenMAX Voltage Barriers for 8-Relay Cabinets, 1 Pair
RGBAR-016	GreenMAX Voltage Barriers for 16-, 32- and 48-Relay Cabinets, 1 Pair

*For GreenMAX Digital Switches and Color Change Kits - see GreenMAX Digital Switches Data Sheet

GreenMAX® Relay Control Panels

<p>Lighting & Controls 10385 SW AVERY ST TUALATIN, OR 97062 (503) 404-5500 http://www.leviton.com</p>	PROJECT: Penn Convention Center Panel Replacement		
	TITLE: Product Cut Sheets	QUOTE: 2244329268	LOCATION: Philadelphia
	REVISION: 1	DATE: 12-02-2022	
	PREPARED BY: Paul Farris		COMPANY PHONE:

LumaCAN Repeater



DESCRIPTION

Leviton's 2- and 6-port repeaters are designed to repeat LumaCAN/CAN data out each port to extend the network length and increase device density, or creating a home-run network topology.

2-port typical application: extend run length

6-port typical application: extend run length and home-run topology

DIMENSIONS - 2-PORT

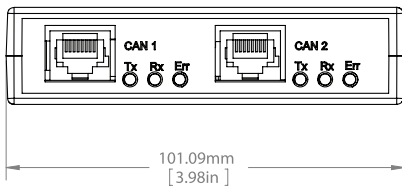
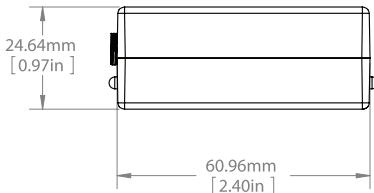

DIMENSIONS - 6-PORT

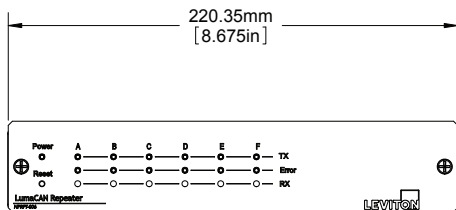

FEATURES

- Expands LumaCAN network configuration options to include star and home run topography
- Extends LumaCAN total network length up to 10,000 ft (3,048m) made up of maximum 1,600 ft (480m) segments
- Six port repeater has "Through" port for port #1
- Max width = 7 repeaters
- Max depth = 3 repeaters
- LED Indicators: RX/Link, TX/Link, Error
- Reset switch
- Update software via USB
- Rack ears included with 6 port repeater for mounting in a standard EIA 19" rack, 1 RU or can be desktop mounted
- 2 port repeater installation is up to the discretion of contractor as required by field conditions; device may be installed into a field box or surface mounted
- Two 6-port repeaters may be installed side-by-side in side-by-side 1RU space

POWER NOTE

Power Supply—requires +12-24VDC, 0.5A. Power supply not included. May be powered from LumaCAN network or dedicated supply

Power Routing—each power can "bridge" power to the adjacent port or segment based on network requirements. Reference document "LumaCAN Power Considerations White Paper" on www.leviton.com for additional details

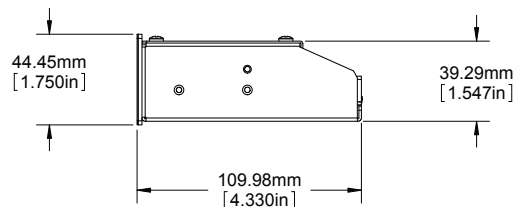

LumaCAN Repeater

<p>Lighting & Controls 10385 SW AVERY ST TUALATIN, OR 97062 (503) 404-5500 http://www.leviton.com</p>	PROJECT: Penn Convention Center Panel Replacement		
	TITLE: Product Cut Sheets	QUOTE: 2244329268	LOCATION: Philadelphia
	REVISION: 1	DATE: 12-02-2022	
	PREPARED BY: Paul Farris		COMPANY PHONE:

WIRING DIAGRAMS

2-PORT REPEATER USED AS NETWORK EXTENDER

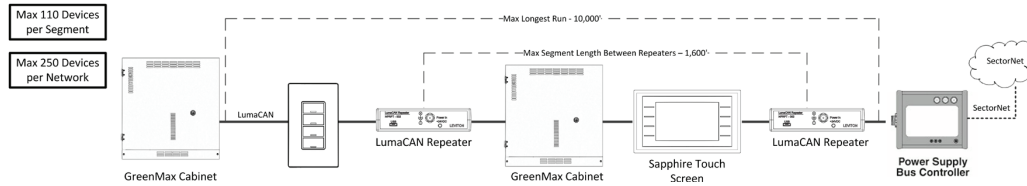

6-PORT REPEATER USED WITH HOME-RUN TOPOGRAPHY

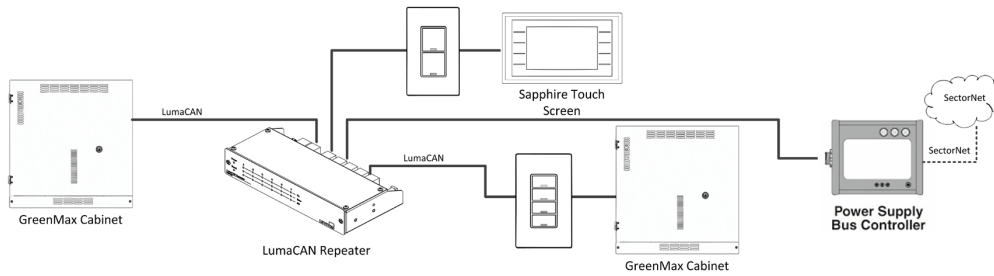

6-PORT REPEATER USED WITH HOME-RUN TOPOGRAPHY

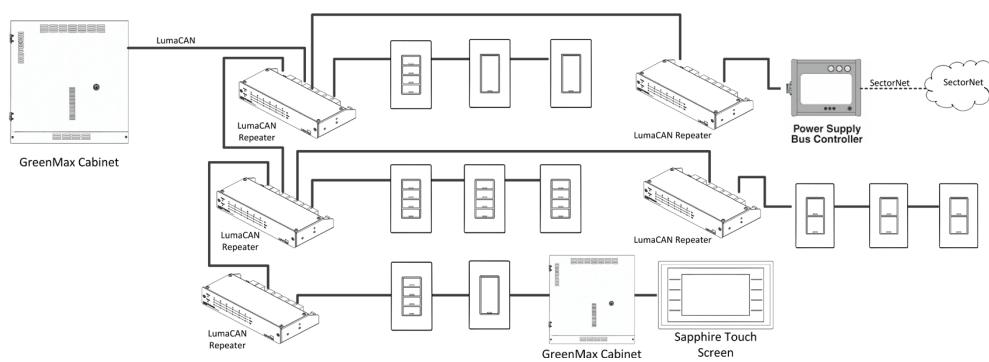

LumaCAN Repeater

SPECIFICATIONS

Power Requirements	+12-24 VDC, can be powered via a LumaCAN bus	
Power Consumption	2-Port	6-Port
	40-80mA	85-170mA
Dimensions	2-Port	6-Port
	3.98" (10.11cm) x 2.4" (6.10cm) x 0.97" (2.46cm)	8.68" (22.04cm) x 4.33" (10.998cm) x 1.55" (3.93cm)
Weight	2-Port	6-Port
	0.1 lbs (0.05kg)	1.6 lbs (0.73kg)
Operating Temperature Range	32°F to 122°F (0°C to 50°C)	
Relative Humidity	5% to 95% non-condensing, for indoor use only	

ORDERING INFORMATION

CAT. NO.	DESCRIPTION
NPRPT-002	LumaCAN 2-Port Pocket Repeater
NPRPT-006	LumaCAN 6-Port Repeater
ACCESSORIES	
EIA00-S01	1RU 19" EIA Rack, surface mount enclosures, opening in side. Removable front cover.

<p>Lighting & Controls 10385 SW AVERY ST TUALATIN, OR 97062 (503) 404-5500 http://www.leviton.com</p>	PROJECT: Penn Convention Center Panel Replacement		
	TITLE: Product Cut Sheets	QUOTE: 2244329268	LOCATION: Philadelphia
	REVISION: 1	DATE: 12-02-2022	
	PREPARED BY: Paul Farris		COMPANY PHONE:

LumaCAN™ Power Supply



Front



Back

DESCRIPTION

The LumaCAN™ Power Supply is designed to provide power to LumaCAN networks. The three independent RJ45 pairs (in/out) supply power to LumaCAN devices and one set of terminals for full power output. It is also capable of providing power to other low voltage devices such as LumaCAN devices, digital switches, Sapphire™ Touch Screens and gateways. The maximum output of the power supply is 4.1A.

APPLICATIONS

- Used to power multiple touch screens
- Used with a repeater when there are many devices on a high current LumaCAN run
- Used when LumaCAN line requires additional power for stations

FEATURES

- 3x current limited power to RJ45 Cat6 networks to protect building wiring
- Separate LumaCAN in/out power supplied to output
- Class 2 output
- Terminals for full 4.1A output power
- Convection cooled
- Auto-reset after overload
- Short circuit protection, continuous trip and restart (hiccup mode)
- Compact mounting—Power Supply is 1/2 RU installing into a traditional 19” EIA equipment rack. Power supply can be mounted side by side with other compatible devices like the repeater and NP00G Gateways to take up a single space.
- Power output through entire operating temperature range
- Power output indicators for each port—indicators shut off when in over-current or short-circuit mode

FRONT PANEL CONFIGURATION

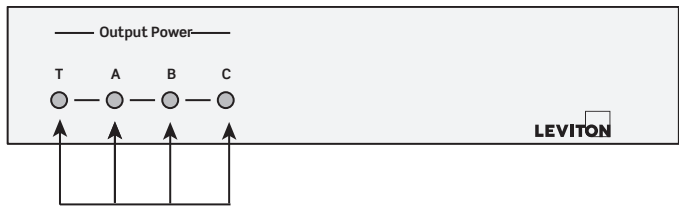

Power Indicators (lit when active, unlit when inactive)

BACK PANEL CONFIGURATION

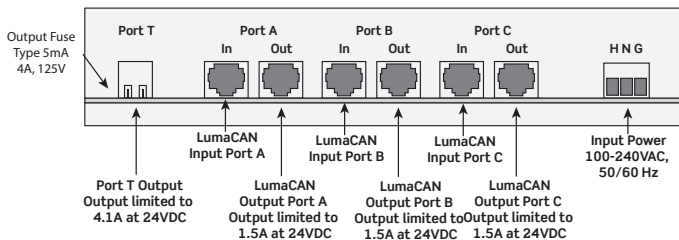

LumaCAN™ Power Supply

<p>Lighting & Controls 10385 SW AVERY ST TUALATIN, OR 97062 (503) 404-5500 http://www.leviton.com</p>	PROJECT: Penn Convention Center Panel Replacement		
	TITLE: Product Cut Sheets	QUOTE: 2244329268	LOCATION: Philadelphia
	REVISION: 1	DATE: 12-02-2022	
	PREPARED BY: Paul Farris		COMPANY PHONE:

PRODUCT DATA



WIRING DIAGRAM

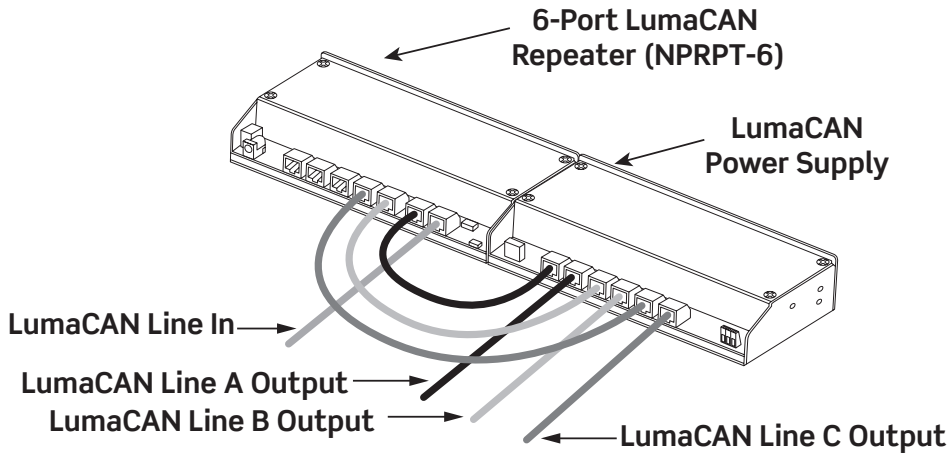

SPECIFICATIONS

ELECTRICAL	
Input	100-240VAC 50/60 Hz, 1.9A Max
Max Output	Regulated +24VDC, 4.1A, 100W
Output	Over-current or short-circuit, automatic recovery, voltage reduction for overcurrent
Output Ports	(4) Max Output rating of 4.1A cannot be exceed, calculate max as sum of output on each port: - Port T, +24V/Com Terminals: 100W, 4A - Port A: LumaCAN, RJ45, 1.5A - Port B: LumaCAN, RJ45, 1.5A - Port C: LumaCAN, RJ45, 1.5A
ENVIRONMENTAL	
Ambient Operating Temperature Range	32 to 104°F (0 to 40°C)
Storage Temperature	-13 to 185°F (-25 to 85°C)
Operating Humidity	0-90% non-condensing
Mean Time Between Failures (MTFB)	>100,000 hours
OTHER	
Dimensions	8.69" (22.09cm) x 4.99" (12.67cm) x 1.54" (3.93cm)
Listings	ETL listed for US and Canada, CE Immunity - EN6100, CE conducted and radiated EMI - EN550022, FCC Class A

ORDERING INFORMATION

CAT. NO.	DESCRIPTION:
PST24-R41	LumaCAN Power Supply
ACCESSORIES	
EIA0-S01	1RU 19" EIA Rack, surface mount enclosure, opening on side

LumaCAN™ Power Supply

<p>Lighting & Controls 10385 SW AVERY ST TUALATIN, OR 97062 (503) 404-5500 http://www.leviton.com</p>	PROJECT: Penn Convention Center Panel Replacement		
	TITLE: Product Cut Sheets	QUOTE: 2244329268	LOCATION: Philadelphia
	REVISION: 1	DATE: 12-02-2022	
	PREPARED BY: Paul Farris		COMPANY PHONE:

Leviton Lighting & Controls Standard Warranty Statement

Leviton Lighting & Controls, a division of Leviton Manufacturing Corporation Inc warrants its Dimmer, Relay, Room Control and Control Systems to be free of material and workmanship defects for a period of two years after system acceptance or 26 months after shipment, whichever comes first. This Warranty is limited to repair or replacement of defective equipment returned Freight PrePaid to Leviton Lighting & Controls at 20947 Teton Ave. Tualatin, Oregon 97062, USA. User shall call 1-800-959-6004 and request a return authorization number to mark on the outside of the shipping carton, to assure that the returned material will be properly received at Leviton. All equipment shipped back to Leviton must be carefully and properly packaged to avoid shipping damage. Replacements or repaired equipment will be returned to sender freight prepaid, F.O.B. factory. Leviton is not responsible for removing or replacing equipment on the job site, and will not honor charges for such work. Leviton will not be responsible for any loss of use time or subsequent damages should any of the equipment fail during the warranty period, but agree only to repair or replace defective equipment returned to its plant in Tualatin, Oregon. This Warranty is void on any product that has been improperly installed, overloaded, short circuited, abused or altered in any manner, or damaged by natural events such as lightning strike, or flood. Neither the seller nor Leviton Manufacturing shall be liable for any injury, loss or damage, direct or consequential arising out of the use of or liability to use the equipment. This Warranty does not cover lamps, ballasts, and other equipment that is supplied or warranted directly to the user by their manufacturer. Leviton makes no warranty as to the Fitness or Purpose of other implied Warranties.

Warranty & Service Program

Factory ECO

- Leviton factory commissioning included with labor and travel expenses 24 hours / 7 days a week telephone support Expert Leviton Field Service Network Convenient product exchange program. Expedited shipping methods available upon request. **SOME ITEMS MAY BE EXCLUDED FROM ENGINEERING SERVICES / COMMISSIONING. REFER TO THE BILL OF MATERIALS FOR MORE INFORMATION.**

Rep ECO

- Rep agency is responsible for performing commissioning included with labor and travel expenses 24 hours/ 7 days a week, telephone support (factory support available). Agency is responsible for all system support for the warranty period(2 years). Parts and labor included.

No ECO

- Purchaser is responsible for commissioning the equipment including all labor and travel expenses. 24 hours / 7 days a week telephone support (factory support available). Purchaser is responsible for all system support for the warranty period (2 years) as per the Standard Warranty Statement above.

 <p style="font-size: small;">Lighting & Controls 10385 SW AVERY ST TUALATIN, OR 97062 (503) 404-5500 http://www.leviton.com</p>	PROJECT: Penn Convention Center Panel Replacement		
	TITLE: Warranty Statement	QUOTE: 2244329268	LOCATION: Philadelphia
	REVISION: 1	DATE: 12-02-2022	
	PREPARED BY: Paul Farris		COMPANY PHONE: